



IP65



IK09



75°



Zéro Halogène

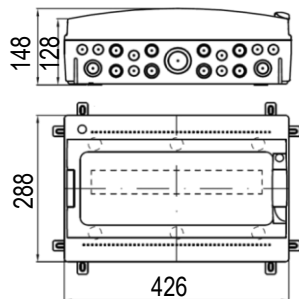
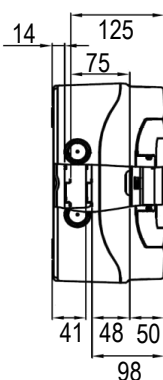

RoHS

SCHEMAS ET COTES (mm)
Dimensions

Réglages des profilés (profondeur)

125 et 98 : distance entre le profilé et la porte

75 et 48 : distance entre le profilé et le plastron modulaire

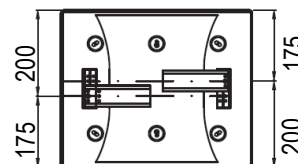
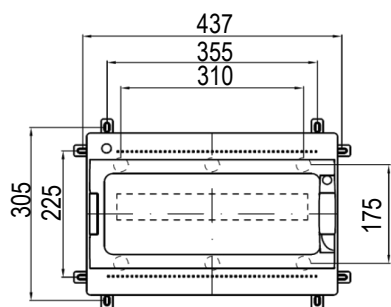
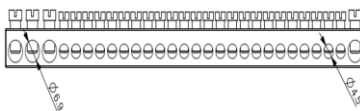
50 : distance entre le plastron modulaire et la porte

Réglages des profilés (entraxe)

Entraxes de fixation

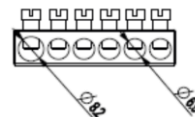
Bornier de terre

Entrées borniers à vis

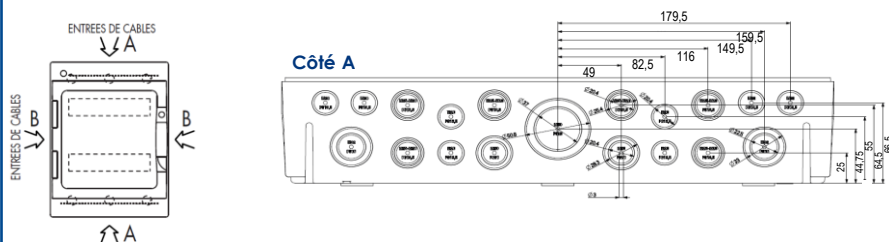
Section	1,5 à 10 mm ²	6 à 25 mm ²
Nombre	24	4

Bornier phase ou neutre

Entrées borniers

Section	35 mm ²	25 mm ²
Nombre	1	5

Prédécoupes des entrées de câbles

Côté A

Type	M50 PG29	M32 PG16	M25 M20 PG13,5	M20 PG21	M20 PG13,5	M16 PG9	M21 PG16	M32 M25	M20 M16 PG9
Nombre	1	2	6	2	8	-	-	2	-

Côté B
Kit de jumelage A-KT
